




Pressing for Excellence

The background of the lower half of the page is a close-up, artistic photograph of a hand ironing a piece of light-colored fabric. The iron's soleplate is visible, and steam is rising from it. The lighting is soft and focused, creating a sense of precision and care. A blue geometric shape, consisting of a vertical bar on the left and a diagonal bar on the right, overlays the top and left sides of the image.

Hand Ironing Technology

Table of Contents

VEIT Training seminars 3

Hand Ironing Technology

Premium Iron (Electronically regulated) 5
 VEIT 2003/2004 Iron Series
 Industrial steam iron VEIT HP 2003

Classic Iron (Thermostat-controlled) 5
 Industrial Steam Iron VEIT 2129

Special Purpose Irons 6
 High-Pressure seam iron VEIT HS 2003
 Dry iron VEIT DI 2004
 Steam Heated Iron BRI-1 and BRI-3
 Special ironing sole for BRI-1
 Hand Finisher VEIT 2157

VEIT Ironing soles 7
 VEIT Frame sole
 VEIT Safety sole
 VEIT Hand Finisher, Frame sole and Brush

Cleaning Agents 7

Accessories 8

Standard Ironing Tables Uniset S/S+B Basic 9

VEIT Building Block System of VEIT Ironing Tables 10

Standard Ironing Tables Varioline S/S+B Classic 11-12
 VEIT Varioline Flat Top S/S+B Classic
 VEIT Varioline DB Surface S/S+B Classic
 VEIT Varioline CR2 S+B Classic

Standard Ironing Tables Varioset S+B Premium 13-14
 VEIT Varioset Flat Top 130 x 65 S+B Premium
 VEIT Varioset DB S+B Premium
 VEIT Varioset CR2 S+B Premium

Special Ironing Tables Varioset Finish S+B 15
 VEIT Varioset Men's/Ladies' Wear Finish table S+B
 VEIT Varioset Men's/Ladies' Wear lining table S+B

Special Ironing Tables Uniset 16
 VEIT Uniset S Trouser seam ironing table

Accessories 16

Steam Generator

VEIT Steam Generators 18-20
 VEIT SG 67
 VEIT SG 66
 VEIT SG 66 MF

Steam Generators 20-21
 VEIT 2373 High-Pressure Steam Generator
 VEIT 2381 High-Pressure Steam Generator

Water Treatment 21
 VEIT Lapidon Lime Binding Agent

Ironing Bucks and Cover Materials

VEIT Group Cover materials 23

VEIT Cover systems for Underpressing 25
 Cover System PREFITT
 Cover System Hard Industrial
 Cover System 3D HARD
 Cover System only for lining finishing stations

VEIT Cover system for Finishing 25-26
 Cover System SOFT INDUSTRIAL
 Cover System 3D SOFT
 Cover System STANDARD

Ironing Surfaces and Covers for base modules 27-28

Ironing Bucks and Covers for Underpressing 28-32

Ironing Bucks and Covers for Finishing 31-33

Technical Data Ironing Tables 34

Technical Data Steam Generators 35

VEIT Training seminars

VEIT hosts one-day intensive ironing seminars. Professional users with profound knowledge share their know-how and their hands-on experience in small groups (8 to 10 participants). Professional ironing performance is your benefit – your customers will be delighted.

Topic: We cover everything from fabrics know-how to ironing methods and finishing. We will be happy to fine-tune the focus of the training to your individual requirements.

Target group: These seminars are particularly suitable for custom tailors, garment manufacturers and textile refinishing companies.

All our intensive ironing seminars are held in our showroom at VEIT Group headquarters in Landsberg am Lech, Germany.

For any further details and/or registration, please contact us:

Phone: +49 (8191) 479 170

E-Mail: seminar@veit.de

We are looking forward to hearing from you.



Seminars Content:

Foundation Knowledge About Finishing

- › Quality - the key to success in the Garment Industry
- › The different influencing factors for the finishing process
- › Basics about the finishing process
- › The secret formula of a high quality finish
- › Understanding suction and blowing
- › Why do we need different steam and temperatures?
- › How do we generate a different steam quality?
- › Which finish applies to the different fabrics?

Hand Ironing

- › Different kinds of irons and when to use them
- › Different iron shoes and when to use them
- › Methods of hand ironing in under pressing
- › Methods of hand ironing in finishing
- › How to avoid shine and seam impressions?
- › What you should know about ironing micro fiber, silk and viscose?
- › How to iron knitwear?
- › Central steam or individual boilers?
- › Why do I need a building block system for tables?
- › What is the right cover system for my table?
- › Reasons for condensate in ironing tables
- › Different ironing bucks and when to use them
- › Basic maintenance of ironing work places
- › Overview about hand ironing products

Finishing

- › What is 3-Dimensional Finishing?
- › How much money can be saved with Finishing?
- › Overview of Form Finishers
- › Overview of Pants Finishers
- › Overview of Tunnel Finishers
- › Overview of Fusing Machines
- › Pressing

How to achieve the highest, consistent quality?

- › The advantage of vertical pressing
- › What is „Distance Pressing“?
- › Overview of Presses

Services

- › Factory Planning
- › Work process & flow diagnosis & improvement
- › Seminars for target staff
- › Energy systems planning, installation and improvements

Hand Ironing Technology



Premium Iron



VEIT 2003/2004 (HP 2003, HS 2003, DI 2004)

Electronically regulated

- > **Consistent quality steam** even when used permanently
- > **Exact temperature regulation with a max. tolerance of $\pm 2^{\circ}$ C.** Thus even very sensitive fabrics can be ironed without shine
- > **High-class hardened and tempered ironing sole.** Very easy gliding of soleplate for ironing without teflon frame sole
- > **Ergonomically shaped and skin-friendly VEIT iron handle** with integrated micro switch for steam release
- > Integrated steam & heat protection **for comfortable and save ironing**
- > **Powerful heating** for short heat-up and short reaction times

Industrial Steam Iron VEIT HP 2003

- > **Electronically regulated temperature control**
- > **Special steam chamber system** inside the soleplate for condensate free steam quality
- > **Particularly gentle steam** application for ironing delicate fabrics
- > **Pointed design of soleplate for excellent ironing results even at areas that are hard to reach**
- > **High reliability, long lifetime, optimal ergonomic design**
Excellent steam quality even at low temperatures
- > **Complete accessory program available:** Teflon and safety sole
Weight approx. 1300 g (w/o cable and hose); 230 V; 1250 W; 50-60 Hz; ironing surface 220 x 105 mm / 8.7 x 4.1 inch

Classic Iron



Industrial Steam Iron VEIT 2129

Thermostat controlled

- > **Thermostat-controlled** (temperature tolerance up to approx. $\pm 15^{\circ}$ C)
- > **Ergonomically shaped and skin-friendly VEIT iron handle** with integrated micro switch for steam release
- > **Integrated steam & heat protection** for comfortable and save ironing
- > **Powerful heating** for quick heatup and short reaction times
- > **Gentle steam application** for ironing delicate fabrics
- > **Soleplate with good gliding characteristics**
- > **Good steam quality also at lower temperatures**
- > **Complete accessory program available:**
Teflon and safety sole
Weight approx. 1500 g (w/o cable and hose); 230 V; 1250 W; 50-60 Hz; ironing surface 220 x 104 mm / 8.6 x 4.1 inch
Available with VEIT plug or square plug to connect to steam generators of other manufacturers.



Special Purpose Iron



High Pressure Seam Iron VEIT HS 2003

This iron was specially designed for underpressing seams. The flat tip in connection with the inclined steam outlet ensures easy opening of seams. The small soleplate saves energy and concentrates it at exactly the right spot.

*Weight of iron approx. 1200 g ; 230 V; 800 W; 50-60 Hz
ironing surface 200 x 40 mm / 7.9 x 1.6 inch*

Special Purpose Iron



Dry Iron VEIT DI 2004

This dry iron with its specially coated aluminium soleplate has very good gliding characteristics. Designed for ironing lining fabrics. The rounded edges of the soleplate avoid the displacement of the lining fabric. A wrinkle-free ironing result is guaranteed.

*Weight of iron approx. 1300 g ; 230 V; 1250 W; 50-60 Hz
ironing surface 210 x 105 mm / 8.3 x 4.1 inch*

Special Purpose Irons



Steam Heated Iron BRI-1 and BRI-3

Steam heated iron for opening seams and removing marks. Iron is equipped with an adjustable and easy to operate steam quantity control valve.

*Weight approx. 1130 g
ironing surface 195 x 60 mm / 7.7 x 2.4 inch*

Special Ironing Sole for BRI-1

Steam holes in the center.

**Especially for machine type:
BRI-165/101**

**Especially for machine type:
166/101**

Special Purpose Iron



Hand Finisher VEIT 2157

Handy but powerful small iron. It is designed for minor corrections during final inspection or for touch-up when using VEIT Multiform Finishers. Also suitable for a variety of other applications like: upholstery, curtain studio, shoe production and automotive industry. We recommend using the VEIT Hand Finisher in connection with our **VEIT Steam Reheater 2218** which provides dry or saturated steam.

*Weight approx. 760 g; 100-240 V; 500 W; 50-60 Hz
ironing surface 125 x 85 mm / 4.9 x 3.4 inch*

VEIT Ironing soles



1) VEIT Teflon Frame Sole

The solid aluminium framed sole gives a snug fit. The teflon frame sole reduces the surface temperature by approx. 30°C-40°C. Available for all VEIT irons except DI 2003/2004.

2) VEIT Safety Sole

The safety sole using the steam chamber principle is made of stainless steel. Various frame plies improve the steam quality and regulate the contact temperature. The additional wire mesh ensures the very fine spread of steam. In addition, the safety sole is also available with a special non-stick coating for fusing interlinings.

3) Teflon Frame Sole and Brush

For VEIT Hand Finisher 2157

Standard equipment includes layers of Aerofit and stainless steel to provide micro fine steam. The teflon frame sole removes creases without shine-marks on flat materials. The brush is used for napped and sensitive fabrics.

- > With layers
- > Brush hard
- > Brush soft
- > Brush Premium

Cleaning agents for heavily soiled iron soleplates

The ironing result depends on the condition of the iron. Therefore, VEIT offers a wide range of accessories and cleaning agents, which readily meet all modern requirements. Although designed for VEIT irons, these accessories are suitable for any other make.

Cleaning Agents



1) VEIT Abrasive Cleaning Stone

Cleaning agent for normally soiled or heavily soiled iron soles. Clean cold iron sole with VEIT abrasive cleaning stone, water and soap.

VEIT Abrasive Cleaning Stone

80 x 50 x 20 mm / 3.2 x 2.0 x 0.8 inch, 1 piece

2) VEIT Fitspray

Cleaning agent for light soiling. For application on the hot iron sole as well as on teflon or frame soles. VEIT Fitspray leaves a clean and antistatic sole to glide smoothly over the garment.

Spray can 330 g

3) VEIT Soleplate pad

Cleaning agent for heavily soiled iron soles.

For application on cold iron sole.

VEIT Soleplate pad, steel-wool, 10 pieces

4) VEIT Cleaner

Cleaning agent for normally soiled iron soleplates. For application on hot iron sole. After a short time, rub with a soft cloth.

Cleaner stick, 100 x 20 mm / 4 x 0.7 inch, 3 pieces

Accessories


1) VEIT Condensor 2210

This connection unit is designed for existing central steam supplies. The condenser discharges condensate, which is built up inside the line, and with its large heat insulated steam chamber, provides the best condensate-free steam quality.

Different versions are available:

- › for connection to central condensate line with condensate trap
- › with connection unit including condensate trap

2) Support Stand

The support stand guarantees the proper function of the VEIT Condensor 2210 as it is automatically mounted in the right position. It includes condensate discharge and dirt trap.

3) Steam Connection Unit VEIT 2215
Steam Adapter VEIT 2215

A control unit for high-pressure steam consumers such as high-pressure irons, steam sprayers, spotting pistols, seam irons etc. The solenoid valve is activated by the micro switch or contactor at the steam unit. Recommended for a condensate-free steam line.

- › for max. 5 bar (73 psi), to be soldered into steam line 1/2"

4) Steam Connection Unit VEIT 2215
Eco Steam Adapter 2215

Like VEIT Steam Adapter 2215 but without connection cable, T-piece and ball valve.

5) VEIT Steam Reheater 2216

Working with a mobile VEIT steam generator, the VEIT 2216 Steam Reheater provides an excellent steam supply for the VEIT Hand Finisher 2157. By overheating the steam, a condensate-free quality steam is achieved. Recommended when using long hoses. 230 V; 1250 W

6) Swivel Holder
for VEIT Steam Generators

Together with a VEIT steam generator, it is the ideal combination as a support for the VEIT Steam Reheater 2216 and as a resting place for the VEIT Hand Finisher 2157.

7) Hose and Cable Supports

To suspend cable and steam hose at the work station or to fasten the VEITronic control unit. *Different versions available.*

8) Iron Rests

Are made of heat resistant silicone to protect the iron sole from damage and to protect the table from excess heat.

Different versions available.

9) Swivel Bow

For HP 2003 iron – for tables with iron gantry. In connection with Mini Balancer a „hovering“ of the iron can be achieved which facilitates the operator's job.

10) High-Pressure Steam Hoses

High quality steam hoses available as a replacement for VEIT irons, but also suitable for other makes of iron. The high-pressure hose for HP irons provides improved steam quality as the condensate is reduced due to teflon core inside the hose and strong silicone insulation outside.

11) Hose Clamps Set

For combining cables and hoses with a diameter of 8–12 mm / 0.3–0.5 inch and for connecting the device to hang up hose and cable supports.

12) VEIT Anti-Shine Spray

This completely natural product removes even the most extreme shine from almost any material. Simply spray the fluid onto the fabric, wait for a few seconds and remove the fluid with steam.

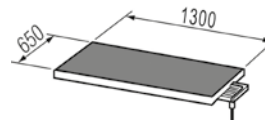
Standard Ironing Table



Picture showing optional items like lighting system and iron gantry

VEIT Uniset Flat Top 130 x 65 S/S+B Basic

- > Designed for the garment industry, studios and alteration shops
- > As suction-only version, it is suitable for underpressing operations like ironing small parts such as collar, cuffs and applying pads
- > As suction and blowing version, suitable for finishing trousers and to avoid marks and shine when ironing sensitive fabrics
- > Height adjustable in six steps (720–950 mm / 28.4–37.4 inch)
- > Good suction and blowing power for short cycle times
- > High suction performance and easy handling due to automatic redirecting of suction/blowing when swivel arm is swivelled in
- > Also available with sound absorber



Uniset S/S+B used for:

- > almost any garment
- > underpressing, if no special tables are available (S/S+B)
- > finishing (S+B only)

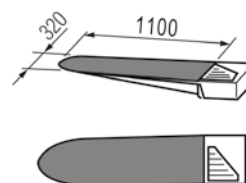
Also available with sound absorber

Standard Ironing Table



VEIT Uniset DB S/S+B Basic

- > Suitable for Ladies' Wear like dresses, skirts and blouses
- > Height adjustable in six steps (720 – 950 mm / 28.4 – 37.4 inch)
- > Good suction and blowing power for short cycle times
- > Manual adjustment of suction/suction and blowing power
- > Equipped with wheels for high flexibility in production
- > Also available with sound absorber
- > High variety regarding accessories and bucks
- > High suction performance and easy handling due to automatic redirecting of suction/blowing when swivel arm is swivelled in



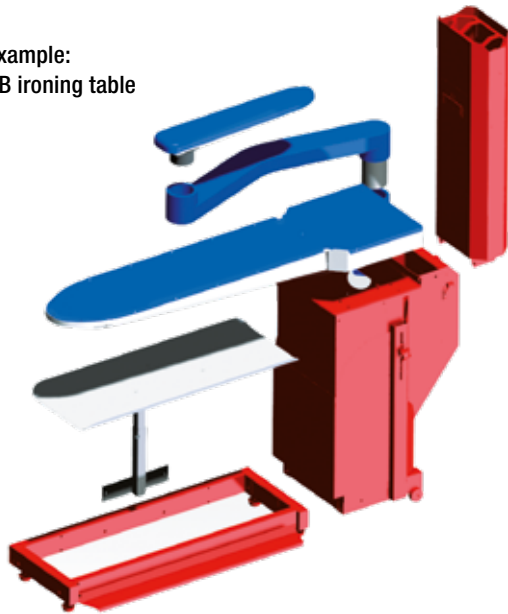
Uniset S/S+B used for:

- > skirts, dresses, blouses, jackets, coats underpressing, if no special tables are available (S/S+B)
- > almost any garment finishing (S+B only)

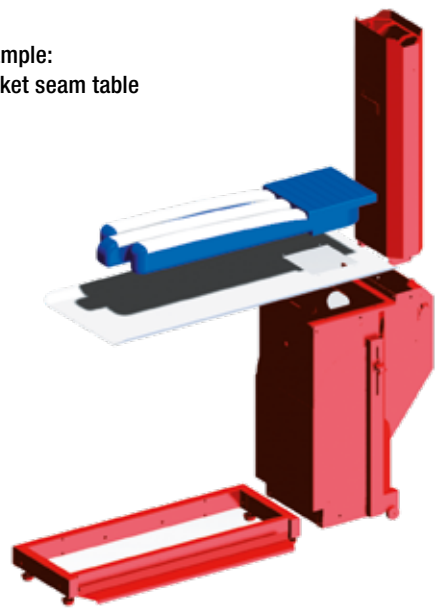
Also available with sound absorber

The Building Block System of VEIT Ironing Tables

Example:
DB ironing table



Example:
Jacket seam table

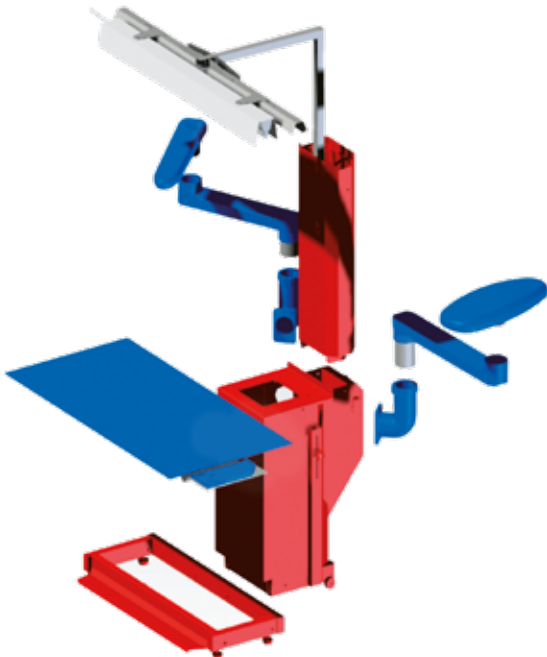


The building block system for ironing tables developed by VEIT has been well-established for years.

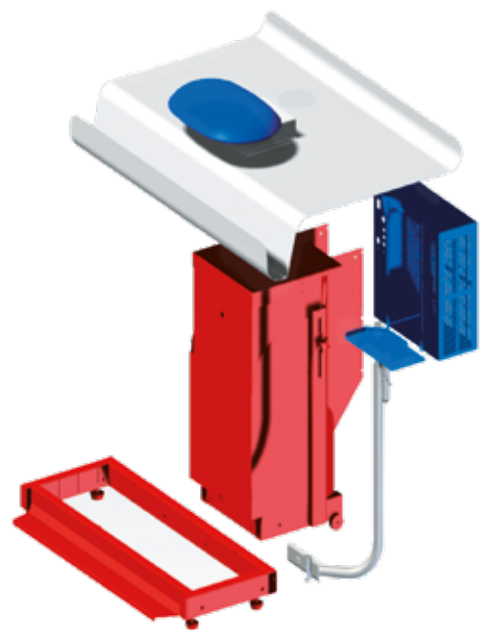
- > **Flexible:** The VEIT tables can be easily adapted to your needs in production
- > **Inexpensive:** You do not need to buy a new table. Just exchange the surface or buck.
- > **Versatile:** The VEIT ironing tables can be adapted to any needs by the huge range of accessories and bucks

The elements marked in red can always be reused, no matter if you need a flat top table, a DB table or special ironing tables.

Example:
Flat top table



Example:
Jacket finish table



Ironing Tables Varioline S/S+B Classic

The new Varioline ironing table series excels with its outstanding suction or suction and blowing power at a low noise level. The automatic switch-over from suction or blowing on the ironing surface to the swivel arm works mechanically. The adjustment of suction and blowing power is done mechanically by flaps as well. The comfortable height adjustment is supported by a gas spring. Its wide range of adjustment (830–990 mm) allows perfect individual adjustment to the operator.

Available as suction only or suction and blowing version.

For your individual needs we offer a wide variety of accessories from our building block system.



The comfortable height adjustment supported by a gas spring with its impressive adjusting range (830–990 mm / 32.7–39.0 inch) provides for an optimal adaption to the operator.



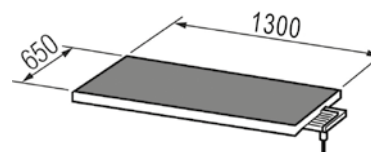
Based on the Varioset and then modified, the flap box made of high quality plastic provides for outstanding power at a low noise level.

Standard Ironing Table



VEIT Varioline Flat Top 130 x 65 S/S+B Classic

- > Designed for the garment industry, studios and tailor shops
- > As suction only version, it is suitable for underpressing operations such as ironing small parts like collar, cuffs and pockets and for applying pads
- > As suction and blowing version, suitable for finishing trousers and for ironing sensitive fabrics both in underpressing and final pressing department
- > Outstanding suction and blowing power with manual power adjustment for short drying and cycle times
- > Low noise level due to elaborate flap box
- > No heating of surface necessary – energy saving
- > Comfortable height adjustment supported by gas spring



Varioline S/S+B used for:

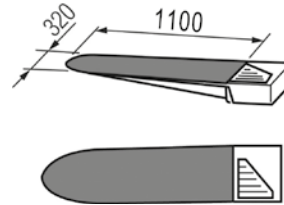
- > almost any garment
- > underpressing, if no special tables are available (S/S+B)
- > finishing (S+B only)

Standard Ironing Table



VEIT Varioline DB Surface S/S+B Classic

- > Suitable especially for operations in Ladies' Wear like dresses, skirts and blouses
- > Outstanding suction and blowing power with manual power adjustment for short drying and cycle times
- > Low noise level due to elaborate flap box
- > No heating of surface necessary – energy saving
- > Comfortable height adjustment supported by gas spring



Varioline S/S+B used for:

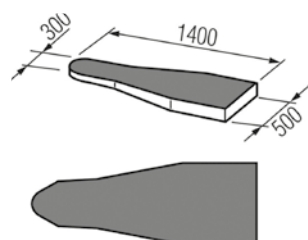
- > skirts, dresses, blouses, jackets, coats
underpressing, if no special tables are available (S/S+B)
- > almost any garment
finishing (S+B only)

Standard Ironing Table



VEIT Varioline CR2 S+B Classic

- > For studios, tailor shops, refinishers and textile care
- > Universal ironing table for trousers, dresses, skirts, coats, blouses and other garments
- > Outstanding suction and blowing power with manual power adjustment for short drying and cycle times
- > Low noise level due to elaborate flap box
- > No heating of surface necessary – energy saving
- > Comfortable height adjustment supported by gas spring
- > Optionally available with integrated egg-shaped buck* for optimal ironing of wider parts of the garment, such as the hip part of trousers. This area can easily be adjusted to a flat or egg-shaped surface by simply operating a lever



- > almost any garment
finishing

*Also available with integrated egg-shaped buck on the tip

Standard Ironing Tables Varioset S+B

The redesigned ironing table series Varioset excels with its superior suction and blowing power at a low noise level. Suction and blowing switches automatically from the surface to the swivel arm. This is electronically controlled. When not in use the swivel arm is shut off completely so that all power is concentrated on the surface.

The exact adjustment of suction or blowing power can be adjusted on the display. The integrated VEITronic allows the temperature adjustment of the iron exactly to the degree.

The comfortable height adjustment supported by a gas spring with its impressive adjusting range (830 mm – 990 mm / 32.7 – 39.0 inch) provides for an optimal adaption to the operator.

For your individual needs we offer a wide variety of accessories.



Suction or blowing power can be exactly adjusted on the display. The integrated VEITronic allows the temperature adjustment of the iron exactly to the degree.



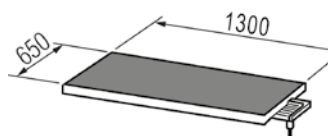
The heart of the Varioset, the flap box provides for outstanding power on the ironing surface as well as on the swivel arm at a low noise level.

Standard Ironing Table



VEIT Varioset Flat Top 130 x 65 S+B Premium

- > Designed for the garment industry, studios and tailor shops
- > As suction and blowing version, it is suitable for finishing trousers and for ironing sensitive fabrics both in underpressing and final pressing department
- > Low noise level due to elaborate flap box
- > No heating of surface necessary – energy saving
- > Comfortable height adjustment supported by gas spring
- > Superior suction and blowing power with independently adjustable air power for fast drying and cycle times
- > Electronic control unit with display and integrated VEITronic for connection of iron



Varioset S+B used for:

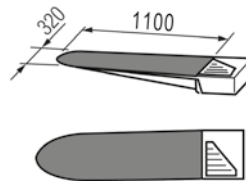
- > almost any garment underpressing, if no special tables are available
- finishing

Standard Ironing Table



VEIT Varioset DB S+B Premium

- > Suitable especially for operations in Ladies' Wear like dresses, skirts, coats and blouses
- > Available as point right and point left
- > **Low noise level** due to elaborate flap box
- > **No heating of surface necessary** – energy saving
- > Comfortable **height adjustment** supported by gas spring
- > **Superior suction and blowing power** with independently adjustable air power for fast drying and cycle times
- > **Electronic control unit with display** and integrated VEITronic for connection of iron



Varioset S+B used for:

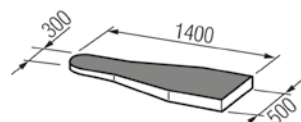
- > skirts, dresses, blouses, jackets, coats finishing

Standard Ironing Table



VEIT Varioset CR2 S+B Premium

- > For studios, tailor shops, refinishers and textile care
- > **Low noise level** due to elaborate flap box
- > **No heating of surface necessary** – energy saving
- > Comfortable **height adjustment** supported by gas spring
- > **Superior suction and blowing power** with independently adjustable air power for fast drying and cycle times
- > **Electronic control unit with display** and integrated VEITronic for connection of iron
- > Optionally available with **integrated egg-shaped buck*** for optimal ironing of wider parts of the garment, such as the hip part of trousers. This area can easily be adjusted to a flat or egg-shaped surface by simply operating a lever



Varioset S+B used for:
> **almost any garment** finishing

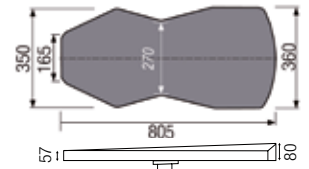
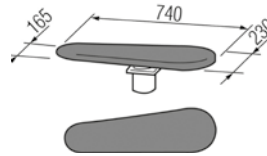
* Also available with integrated egg-shaped buck on the tip

Special Ironing Table



VEIT Varioset Men's/Ladies' Wear Finish Ironing Table S+B

- > For jackets, blazers, costumes
- > Specially shaped spilltray for wrinkle-free support of the garment
- > Different buck shapes mountable, such as universal buck, costume buck and others
- > Low noise level due to elaborate flap box
- > No heating of surface necessary – energy saving
- > Comfortable height adjustment supported by gas spring
- > Superior suction and blowing power with independently adjustable air power for fast drying and cycle times
- > Electronic control unit with display and integrated VEITronic for connection of iron



Varioset S+B used for:
> jackets, blazers, costumes finishing

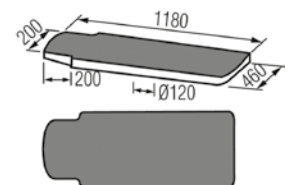
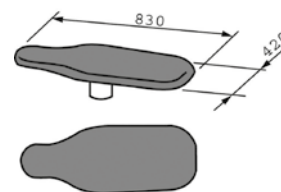
Also available with ladies' buck

Special Ironing Table



VEIT Varioset Men's/Ladies' Wear Lining Table S+B

- > Convex: surface is slightly convexly shaped in order to prevent the outer fabric from being touched by the iron in the facing area
- > Concave: Surface is concave in order to keep the shape of the garment. This guarantees optimal position of the garment in the area of the armhole. Optional: shoulder seam attachment kit.
- > All lining bucks are rotatable by 180° and can thus be used as point right or left
- > Comfortable height adjustment supported by gas spring
- > Superior suction and blowing power with independently adjustable air power for fast drying and cycle times
- > Electronic control unit with display and integrated VEITronic for connection of iron



Varioset S+B used for:
> jackets, blazers finishing

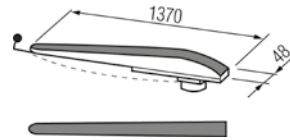
Also available with concave buck

Special Ironing Table



VEIT Uniset S Trousler Seam Ironing Table

- > The **special buck** allows the easy opening of crotch and side seams
- > Available for **Men's and Ladies' Wear**; Timer available as an option
- > **Optionally available with chain** for ideal positioning and avoidance of wrinkles in the seam area
- > **Height adjustable** in six steps from 720–950 mm/ 28.4–37.4 inch
- > **High suction power** for short drying and cycle times
- > **Heated buck for condensate free ironing**



Uniset S+B used for:
> trousers underpressing



Optionally available with chain

Accessories



Lighting and Iron Gantry



Swivel Arms

Lighting and Iron Gantry

Available for all ironing table series. Improves the work station layout and prevents early operator fatigue.

Swivel Arms

For each ironing table there are special requirements. So VEIT offers different versions to equip each table with the most ergonomic swivel arm.



Ironing Bucks



Spill Trays

Ironing Bucks

For each garment VEIT offers specially made bucks to iron certain areas quickly and with a perfect result.

Spill Trays

VEIT offers a big variety of spill trays. These allow the operator to lay down the part of the garment that is not being ironed without causing wrinkles.



Steam Generators

Taking SteamGenerators to the next level

Adjustable steam quality

Select dry or moist steam for processing different types of products

Direct water connection without additional container

automatic refilling, no additional space needed

Easy access for maintenance and servicing.

Longer operating hours without refilling enlarged container capacity

Stainless steel boiler

for applications with special hygiene requirements

Integrated locking castors for flexible mobility on site



Three performance levels

with steam capacities from 3 to 9 kg per hour

2.2 kW – 230 V for 3.0 kg steam/h, one connection, e. g. for one iron

4.4 kW – 400 V for 6.0 kg steam/h, two connections, e. g. for two irons

6.6 kW – 400 V for 9.0 kg steam/h, two connections, e. g. for two AS-irons, very short heating time

All these versions are also available with a ball valve which can be used with all-steam irons or other steam units.

eMotion

Our holistic *eMotion* approach was very much in the focus when developing our new machine generation. Your production will sustainably benefit from the economic use of resources:

- > Energy savings through pre-heated feedwater
- > Reduced air-conditioning costs thanks to extremely low heat radiation of machine
- > The reduced heat radiation creates a pleasant work environment with satisfied employees and little absenteeism

Can be used with distilled water and with reverse osmosis water.

Versatile connections for up to two workplaces, steam reheaters and spotting tables

Automatic cleaning system with VEIT SteamClean keeps the unit clean and extends the components' lifespan

Safe automatic filling avoids running dry and thus makes venting redundant

Operation with distilled water* and reverse osmosis water possible no blow down required in this case

Integrated iron connections for safe and comfortable connection of up to two units

Top facing valve for blow-down more ergonomic user friendliness with bigger distance to hot steam

Small dimensions more power on less space

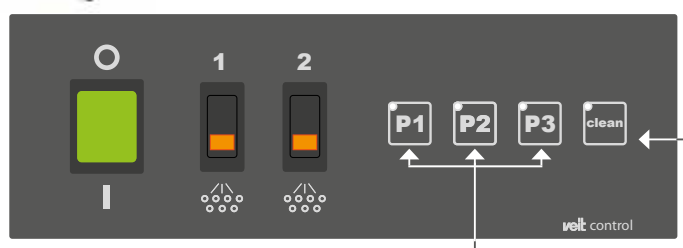


Any ancillary equipment available by VEIT can be fully integrated to create a customized work place around your steam generator. This includes a steam reheater, the Detaset spotting unit, hose and cable supports and a holder for the hand finisher



veit SteamClean

In combination with the SteamClean cleaning agent, the automatic cleaning cycle replaces the daily blow-down procedure and protects the boiler against calcification and corrosion for a long time.



The VEIT Control Unit provides a choice between three power levels. By selecting more or less humid steam for different product groups, customized settings are perfectly easy to implement.

*Full functionality is guaranteed from a conductivity of 2.5 µS/cm. With 1.5 - 2.5 µS/cm limited operation if necessary. Under 1.5 µS/cm there is no guarantee of functionality.

Steam Generator



VEIT SG 66 MF

- > 2.2 kW – 230 V for 3.0 kg steam/h, solenoid valve for connecting the iron
- > **Inexpensive compact steam generator** with long-life stainless steel boiler
- > **Ideal for use in tailor shops**
- > Steam generated from tap water
- > **Steam generator and heating of iron can be controlled separately**
- > **Electronic water level indicator with acoustic signal**
- > For refilling, pressure can be released quickly through venting
- > **Includes safety blow-down tank**

Steam Generator



VEIT SG 66

- > 2.2 kW – 230 V for 3.0 kg steam/h, solenoid valve for connecting the iron
- > **Compact steam generator** with long-life stainless steel boiler
- > **Automatic water feed-in** through built-in pump (for direct water connection or feedwater tank)
- > Acoustical and optical water level indicator
- > **Safety features** same as 2365
- > No direct water connection necessary
- > **Includes safety blow-down tank**

Feedwater connection kit for VEIT 2366

For using the VEIT 2366 steam generator without direct feedwater connection.

Steam Generator



VEIT 2373 High-Pressure Steam Generator

- 13,5 kW – 400 V for 18 kg steam/h
- 18 kW – 400 V for 24 kg steam/h
- 24,5 kW – 400 V for 33 kg steam/h
- 30 kW – 400 V for 41 kg steam/h
- Connection for irons, finishers and other steam consumers**
- > Compact design
- > **Stainless steel feedwater tank**
- > The steam generator can be placed against a wall, as all energy supply connections are accessible from the side
→ **easy maintenance / saves space**
- > Boiler volume 22 litres
- > **Safety plastic blow-down tank**
- > For service, all functional components are easily accessible from the front
- > High-temperature feedwater pump ensures **high operating safety**

For major steam requirements, please contact our department „Energy Systems“ for further information and support.

Steam Generator



VEIT 2381 High-Pressure Steam Generator

40 kW / 400 V for 55 kg steam/h
 50 kW / 400 V for 68 kg steam/h
 60 kW / 400 V for 78 kg steam/h

- Connection for irons, finishers, up-steam tables and others.**
- > **Optimized steam supply and maximum operating safety** thanks to a 75-litre tank (50 l water and 25 l steam)
 - > **Easy installation, operation and maintenance** through clearly arranged operating panel
 - > **Integrated stainless steel feedwater and blow-down tanks** in tubular compact design
 → **low installation costs / increased safety**
 - > High temperature feedwater pump ensures high operating safety
 - > **High operating safety** ensured by electronic control of water level and a double protection against low water: no running dry of heating elements
 - > **Large heating elements** with low surface load protect the heating rods and extend the life span
 - > The blow-down process is carried out safely from the front of the steam generator
 - > The VEIT 2381 steam generator fulfills the requirements of the Pressure Equipment Directive (PED) category III. In Germany, this steam generator can be installed without inspection and approval by the authorities → **cost saving**

Connection kit for tandem operation for steam generator VEIT 2381

For increased steam quantities, two steam stations can be placed on top of each other (tandem operation). This saves space and supplies up to 164 kg steam/h.

Water Treatment



VEIT Lapidon Lime Binding Agent

Lime in water calcifies the boiler and the heating elements, which might cause breakdowns. We therefore recommend the use of the binding agent VEIT Lapidon if the water hardness exceeds 5°dH (German hardness).

The binding agent prevents deposits of lime. The lime will be removed from the boiler during blow-down.

Excellent water quality is an important requirement for steam production and steam distribution.

It helps to save energy, reduces breakdowns and increases the working life of your units. For calcareous water (5°dH German water hardness or more) we recommend water treatment. To eliminate unfavourable substances like chlorine, iron, salts etc., we offer expert advice and will be pleased to submit an individual quotation.



Ironing Bucks and Cover Materials

VEIT Group Cover Materials



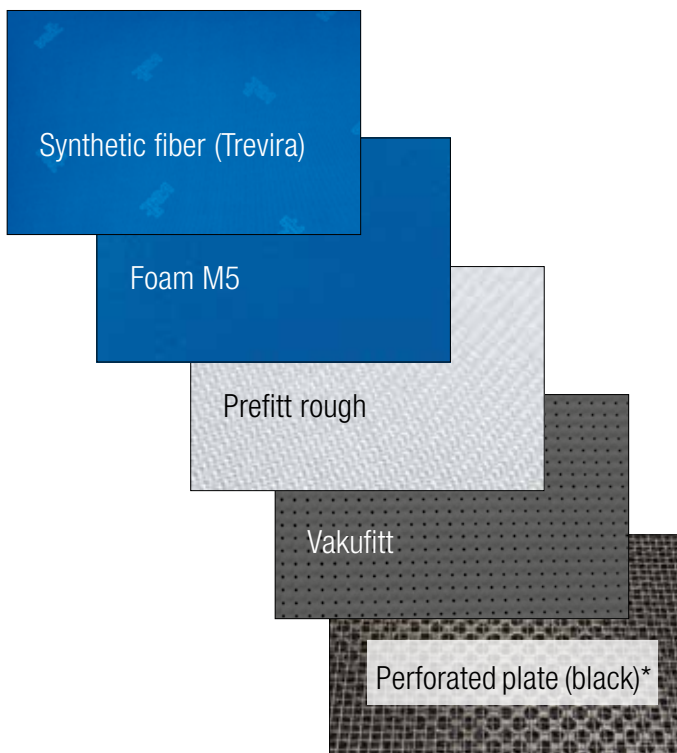
The choice of cover materials is crucial for the finishing result. A firm cover system is needed for opening seams, for example, whereas a very soft cover will be required for finishing interlinings.

It is not only the quality and durability of a cover system that counts, but also its air permeability, which allows sufficient suction to prevent the cover from absorbing humidity. This prevents unwanted moistening of the cover.

VEIT cover systems meet all the above requirements. They have been developed on the basis of extensive testing and research. However, even VEIT cover systems are subject to wear and tear and must be regularly cleaned or exchanged in order to maintain the excellent performance of VEIT ironing machines.

For optimal results, we recommend using VEIT cover materials exclusively.

VEIT Cover system for Finishing



Cover System SOFT INDUSTRIAL

Only for use with black perforated plate

Benefits of individual layers:

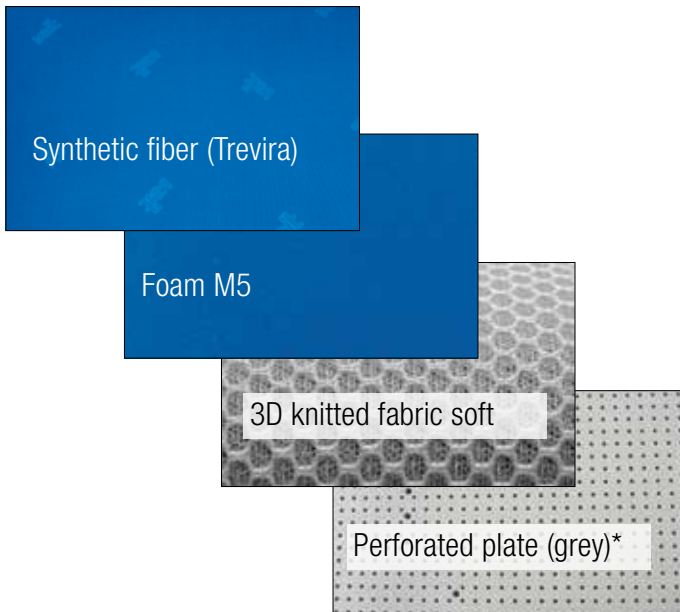
- > **Synthetic fiber (Trevira):** Rapid movement of garment, long life, short-term heat-resistance up to 230°C, washable with 30°C
- > **Foam:** 5 mm, as cushion for covers
- > **Prefitt rough:** This adjusting fibre guarantees the complete dispersion of the condensate drops and reduces the humidity in the cover system
- > **Vakufitt:** Silicon mat spreads the air flow evenly over the entire surface (on ironing table and bucks the curved surface has to face up)

Benefits of cover system SOFT INDUSTRIAL:

- > Universal cover for nearly all final pressing operations
- > Long life cover
- > Precise cutting with reinforced border gives easy crease-free covering of ironing surfaces and bucks
- > Suitable **only** for use with black perforated plate

* Description see page 24

VEIT Cover system for Finishing


Cover System 3D SOFT

For use with grey perforated plate with Dress Board Narrow; Flat Top 130x65; CR2 (equals "SOFT INDUSTRIAL")

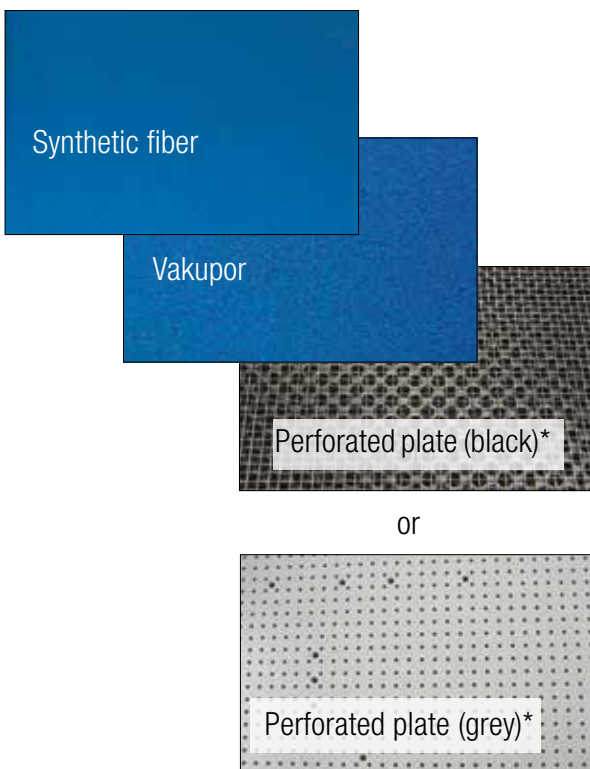
Benefits of individual layers:

- > **Synthetic fiber (Trevira)**: Rapid movement of garment, long life, short-term heat-resistance up to 230°C, washable with 30°C
- > **Foam**: 5 mm, as cushion for covers
- > **3D knitted fabric**: 10 mm knitted polyester fabric, high air permeability. Hand wash, long durability

Benefits of cover system 3D SOFT:

- > Universal cover for nearly all final pressing operations
- > Long life cover
- > High air permeability
- > Easy to fix, few layers
- > Recommended for use with grey perforated plate, also possible with black perforated plate

VEIT Cover system for Finishing


Cover System STANDARD
Benefits of individual layers:

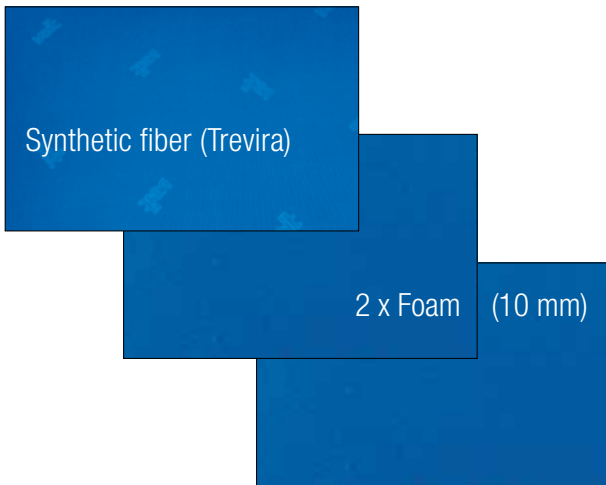
- > **Synthetic fiber**: Economically priced alternative, short-term heat-resistance up to 180°C, washable with 30°C
- > **Vakupor**: PU-foam of polyester, high air permeability, water-resistant, washable, long durability

Benefits of cover system STANDARD:

- > Low-priced alternative for universal use
- > Easy to fix
- > For use with black and grey perforated plate

* The black perforated plates have uniform punched holes over the whole surface. For an optimised airflow Vakufitt is used. With the grey perforated plates this uniform air flow distribution is integrated into the punching pattern making the use of Vakufitt unnecessary. The use of Vakufitt with the grey perforated plates is not recommended as it will plug up the holes in the surface. Therefore please use the 3D knitted fabric.

VEIT Cover system for Finishing



Cover system only for Lining Finishing station

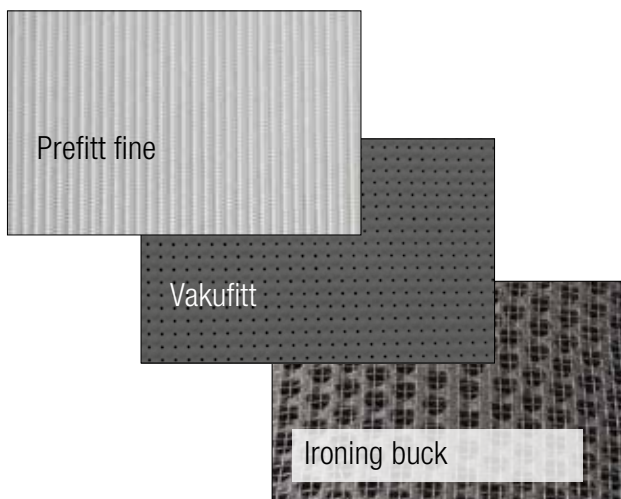
Benefits of individual layers:

- > **Synthetic fiber (Trevira):** Rapid movement of garment, long life, short-term heat-resistance up to 230°C, washable with 30°C
- > **Foam:** 10 mm, as cushion for covers

Benefits of cover system Lining Finishing:

- > Very soft to avoid impressions
- > High air permeability

VEIT Cover system for Underpressing



Cover System PREFITT

For bucks uses for opening seams

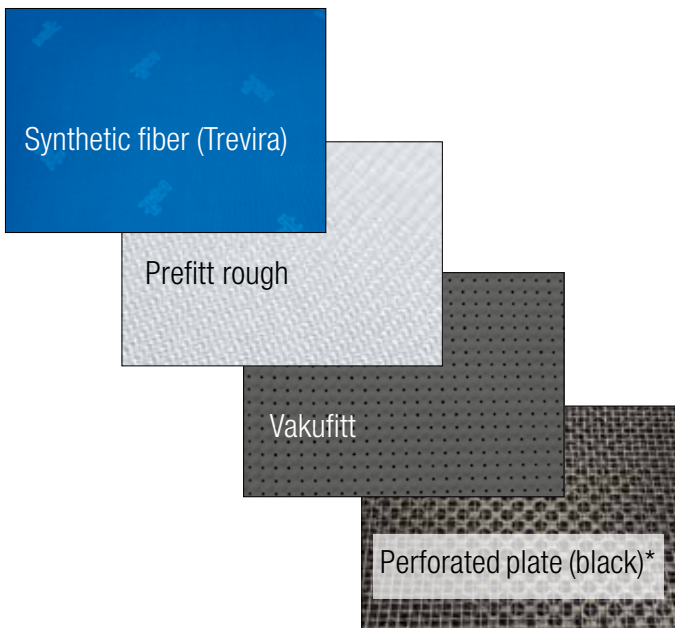
Benefits of individual layers:

- > **Prefitt fine:** Polyester, especially for fabrics that are subject to shine; mostly used with hard covers (seam ironing)
- > **Vakuffitt:** Silicon mat spreads the air flow evenly over the entire surface (on ironing table and bucks the curved surface has to face up)

Benefits of cover system PREFITT:

- > Advantageous for gabardine and poplin and dark fabrics which are subject to shine
- > Avoids shine and pressure marks

VEIT Cover system for Underpressing



Cover System HARD INDUSTRIAL

For Ironing small pieces, e. g. cuffs, facings, collars and hems

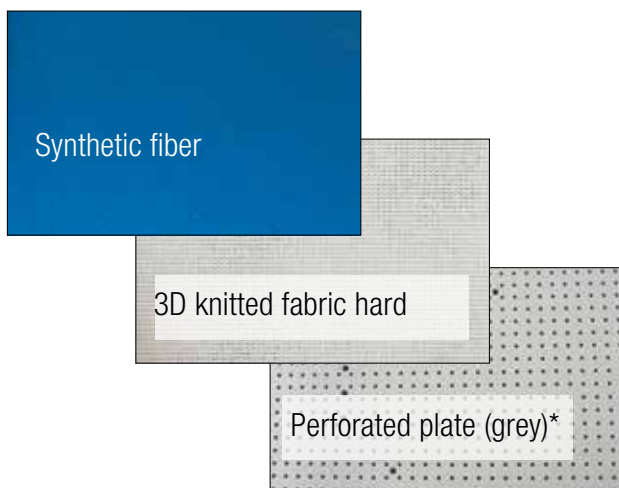
Benefits of individual layers:

- > **Synthetic fiber (Trevira)**: Rapid movement of garment, long life, short-term heat-resistance up to 230°C, washable with 30°C
- > **Prefitt rough**: This adjusting fibre guarantees the complete dispersion of the condensate drops and reduces the humidity in the cover system
- > **Vakufitt**: Silicon mat spreads the air flow evenly over the entire surface (on ironing table and bucks the curved surface has to face up)

Benefits of cover system HARD INDUSTRIAL:

- > Suitable for ironing small parts such as flaps, welts and cuffs
- > Especially suitable for unproblematic fabrics
- > Suitable only for use with black perforated plate

VEIT Cover system for Underpressing



Cover System 3D HARD

For use with grey perforated plate with Dress Board Narrow; Flat Top 130x65; CR2 (equals "HARD INDUSTRIAL")

Benefits of individual layers:

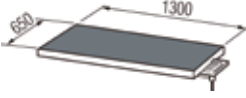





- > **Synthetic Fiber**: Economically priced alternative, short-term heat-resistance up to 180°C, washable with 30°C
- > **3D knitted fabric**: 6 mm knitted polyester fabric, high air permeability. Hand wash, long durability

Benefits of cover system 3D-HARD:

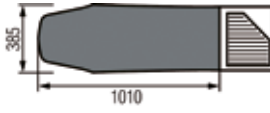

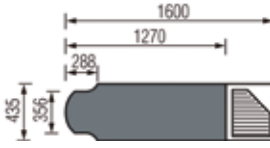

- > Suitable for ironing small parts such as flaps, welts and cuffs
- > High air permeability
- > Easy to fix
- > Recommended for use with grey perforated plate, also possible with black perforated plate

* Description see page 24

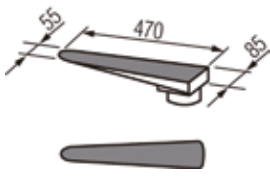




Ironing Surfaces and Covers for Base Moduls

Illustration	Description	Order No.	Use				
	Universal Surface 1300 x 650 mm / 51.2 x 25.6 inch Universal Surface 1300 x 650 mm with heating Cover: Prefitt Soft Industrial Standard Cover System 3D hard Cover System 3D soft	243 072 015 0 243 073 015 0 344 352 089 0 344 352 095 0 344 352 099 0 124 548 124 546					
	Universal Surface 1400 x 800 mm / 55.1 x 31.5 inch Cover: Prefitt Soft Industrial Standard	243 072 004 G 343 812 089 G 343 812 095 G 343 812 099 G					
	Universal Dress board narrow with iron rest Cover: Prefitt Soft Industrial Standard Cover System 3D hard Cover System 3D soft	241 072 016 0 341 012 089 G 341 012 095 G 341 012 099 G 124 547 124 170					
	Universal Dress board wide with iron rest Universal Dress board wide with iron rest and heating Cover: Prefitt Soft Industrial Standard	241 072 002 0 241 073 002 0 310 952 089 G 310 952 095 G 310 952 099 G					
	Universal Dress board skirt with iron rest Cover: Prefitt Soft Industrial Standard	241 072 009 0 342 372 089 G 342 372 095 G 342 372 099 G					
	Universal Surface CR2 Cover: Soft Industrial Standard Cover System 3D soft	241 072 005 0 342 362 095 G 342 362 099 G 114 887					

Ironing Surfaces and Covers for Base Moduls

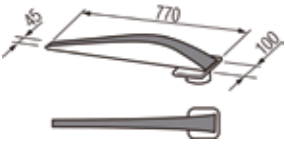

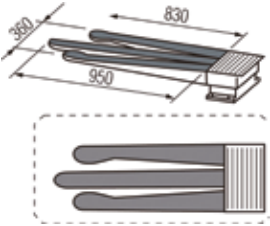

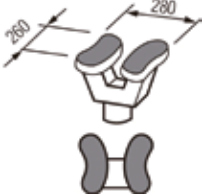

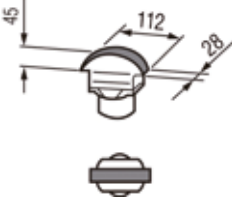

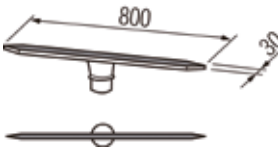

Illustration	Description	Order No.	Use
	Surface for blouses and shirt finish with iron rest Cover: Soft Industrial	243 072 013 0	
		343 072 095 0	
	Surface for coats with iron rest Cover: Soft Industrial	243 072 011 0	
		341 112 095 0	

Ironing Bucks and Covers for Underpressing

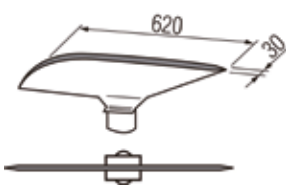

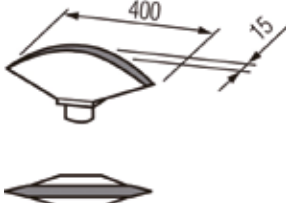



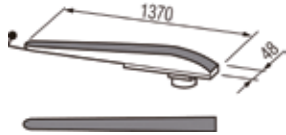

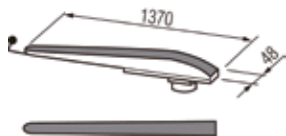

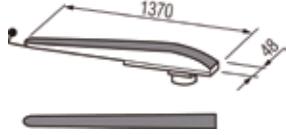

	Sleeve buck small with plinth diameter 85 mm / 3.35 inch Cover: Prefitt Soft Industrial Hard Industrial Standard	249 131 051 G	
		310 512 089 G	
		310 512 095 G	
		310 512 096 G	
		310 512 099 G	
	Sleeve buck medium with plinth diameter 85 mm / 3.35 inch Cover: Prefitt Soft Industrial Hard Industrial Standard Soft Standard	249 131 065 0	
		310 522 089 G	
		310 522 095 G	
		310 522 096 G	
		310 522 099 G	
	Sleeve buck large with plinth diameter 85 mm / 3.35 inch Cover: Prefitt Hard Industrial Standard	249 131 053 G	
		310 532 089 G	
		310 532 096 G	
		310 532 099 G	

VEIT cover materials are also available in running meters with special quantity discounts.

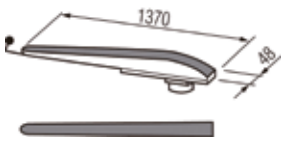

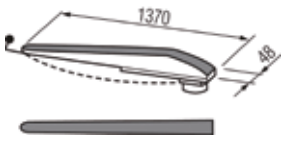

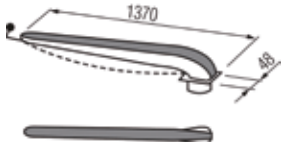

Ironing Bucks and Covers for Underpressing

Illustration	Description	Order No.	Use
	<p>Sleeve buck small with plinth diameter 85 mm / 3.35 inch</p> <p>Sleeve buck special with plinth diameter 120 mm / 4.72 inch with iron rest</p> <p>Cover: Prefitt Hard Industrial</p>	<p>249 131 042 G</p> <p>249 251 042 G</p> <p>310 422 089 G</p> <p>310 422 096 G</p>	
	<p>Triple jacket seam buck</p> <p>Cover: Prefitt Hard Industrial</p>	<p>249 221 025 G</p> <p>310 252 089 G</p> <p>310 252 096 G</p>	
	<p>Double shoulder seam buck with plinth diameter 85 mm / 3.35 inch</p> <p>Cover: Prefitt Hard Industrial</p>	<p>249 131 015 0</p> <p>310 152 089 G</p> <p>310 152 095 G</p>	
	<p>Sleeve head buck with plinth diameter 85 mm / 3.35 inch</p>	<p>132 468</p>	
	<p>Edge buck medium with plinth diameter 85 mm / 3.35 inch</p>	<p>249 131 060 0</p>	

Ironing Bucks and Covers for Underpressing

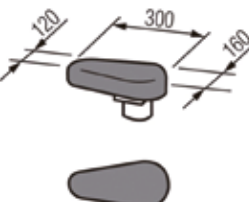
Illustration	Description	Order No.	Use
	Edge buck blazer with plinth diameter 85 mm / 3.35 inch	249 131 003 0 _____ _____ _____ _____	
	Collar outer seam buck with plinth diameter 85 mm / 3.35 inch	249 131 041 0 _____ _____ _____ _____	
	Collar buck with plinth diameter 85 mm / 3.35 inch	249 131 069 0 _____ _____ _____ _____	
	Trouser seam buck men's wear with plinth diameter 85 mm / 3.35 inch with heating and turning handle height with cover: 95 mm / 3.74 inch Cover: Prefitt	249 135 081 0 _____ _____ 320 252 089 0 _____	
	Trouser seam buck men's wear with plinth diameter 120 mm / 4.72 inch with heating and turning handle height with cover: 95 mm / 3.74 inch Cover: Prefitt	249 255 046 0 _____ _____ 320 252 089 0 _____	
	Trouser seam buck ladies' wear with plinth diameter 85 mm / 3.35 inch with heating and turning handle height with cover: 145 mm / 5.71 inch Cover: Prefitt	249 135 082 0 _____ _____ 321 252 089 0 _____	

Ironing Bucks and Covers for Underpressing

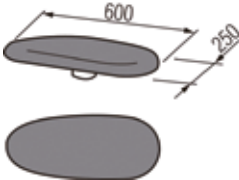

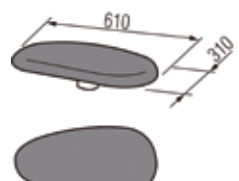

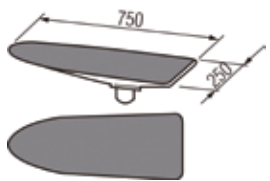

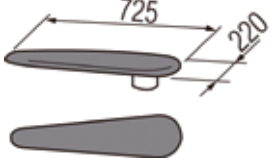

Illustration	Description	Order No.	Use
	Trouser seam buck ladies' wear with plinth diameter 120 mm / 4.72 inch* with heating and turning handle height with cover: 145 mm / 5.71 inch Cover: Prefitt	249 255 047 0	
		321 252 089 0	
	Trouser seam buck men's wear with chain and plinth diameter 120 mm / 4.72 inch* with heating, cover and turning handle Cover: Prefitt chain	249 255 048 0	
		320 252 089 0	
		449 251 011 0	
	Trouser seam buck ladies' wear with chain and plinth diameter 120 mm / 4.72 inch with heating, cover and turning handle Cover: Prefitt chain	249 255 049 0	
		320 252 089 0	
		449 251 011 0	

* Trouser seam bucks also available with plinths 85 mm / 3.35 inch for swivelarms (Order No.: 249 135 081 0)



Ironing Bucks and Covers for Underpressing and Finishing

	Shoulder buck ladies' wear with plinth diameter 85 mm / 3.35 inch Cover: Prefitt Soft Industrial Hard Industrial Standard	249 131 049 0	
		310 492 089 G	
		310 492 095 G	
		310 492 096 G	
		310 492 099 G	
	Universal buck small with plinth diameter 85 mm / 3.35 inch Cover: Soft Industrial Hard Industrial Standard	249 131 076 0	
		310 762 095 G	
		310 762 096 G	
		310 762 099 G	

Ironing Bucks and Covers for Underpressing and Finishing

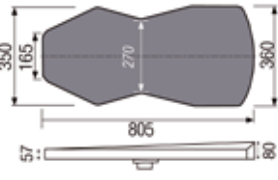

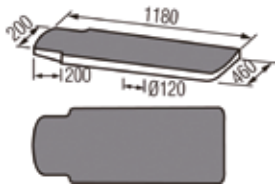

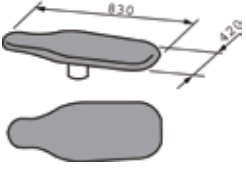





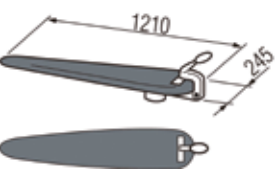

Illustration	Description	Order No.	Use
	Egg-shaped buck small GRP* with plinth diameter 85 mm / 3.35 inch	249 131 054 0	
	Egg-shaped buck small with plinth diameter 120 mm / 4.72 inch	249 251 054 0	
	Cover:		
	Soft Industrial	310 542 095 G	
	Hard Industrial	310 542 096 G	
Standard	310 542 099 G		
Soft Standard	310 542 081 0		
	Egg-shaped buck large GRP* with plinth diameter 85 mm / 3.35 inch	248 131 055 0	
	Cover:		
	Soft Industrial	310 552 095 G	
	Hard Industrial	310 552 096 G	
	Standard	310 552 099 G	
	Skirt buck with plinth diameter 85 mm / 3.35 inch	249 131 057 G	
	Cover:		
	Prefitt	310 572 089 G	
	Soft Industrial	310 572 095 G	
	Hard Industrial	310 572 096 G	
Standard	310 572 099 G		
	Trousers waistband buck with plinth diameter 85 mm / 3.35 inch	249 131 011 G	
	Cover:		
	Soft Industrial	310 772 095 G	

Ironing Bucks and Covers for Finishing

	Universal buck long with plinth diameter 85 mm / 3.35 inch	249 131 077 G	
	Universal buck long with plinth diameter 120 mm / 4.72 inch	249 251 077 G	
	Cover:		
	Prefitt	310 772 089 G	
	Soft Industrial	310 772 095 G	
Hard Industrial	310 772 096 G		
Standard	310 772 099 G		

*GRP glass fibre reinforced

Ironing Bucks and Covers for Finishing

Illustration	Description	Order No.	Use
	<p>Finish buck dress board standard with plinth diameter 120 mm / 4.72 inches Cover: Soft Industrial</p>	<p>249 251 088 0</p> <p>310 8822 095 0</p>	
	<p>Jacket lining buck concave with plinth diameter 120 mm / 4.72 inch (recommended for men's and children's wear) Cover: Soft Standard</p>	<p>249 251 038 0</p> <p>310 382 091 0</p>	
	<p>jacket lining buck convex with plinth diameter 120 mm / 4.72 inch (recommended for ladies' wear) Cover: Soft Standard</p>	<p>248 251 037 0</p> <p>310 372 091 G</p>	
	<p>Additional unit shouder-finish men's wear with plinth diameter 85 mm / 3.35 inch Cover: Standard</p>	<p>249 131 100 0</p> <p>311 002 099 0</p>	
	<p>Additional unit shouder-finish ladies' wear with plinth diameter 85 mm / 3.35 inch Cover: Standard</p>	<p>249 131 083 0</p> <p>310 832 099 0</p>	
	<p>Trousers leg universal buck with clamp and plinth diameter 120 mm / 4.72 inch Cover: Soft Industrial Hard Industrial</p>	<p>249 251 018 G</p> <p>310 182 095 G</p> <p>310 182 096 G</p>	

Ironing Tables

Type	Page	Dimensions		Connections			
		L x W x H mm (inch)	Weight kg	Steam max kg/h	Voltage V/kw	Steam pressure bar	Steam connection
VEIT Uniset Flat top 130x65 S/S+B Basic	9	1300 x 810 x 1775 (51.2 x 31.9 x 69.9)	74	–	230	–	–
VEIT Uniset DB S/S+B Basic	9	575 x 1440 x 1775 (22.6 x 56.7 x 69.9)	74	–	230	–	–
VEIT Varioline Flat top 130x65 S/S+B Classic	11	1300 x 895 x 2100 (51.2 x 35.2 x 82.7)	115	–	230	–	–
VEIT Varioline DB S/S+B Classic	12	500 x 1620 x 2100 (19.7 x 63.8 x 82.7)	115	–	230	–	–
VEIT Varioline CR2 S+B Classic	12	800 x 1620 x 2100 (31.5 x 63.8 x 82.7)	115	–	230	–	–
VEIT Varioset Flat top 130x65 S+B Premium	13	1300 x 895 x 2100 (51.2 x 35.2 x 82.7)	115	–	400	–	–
VEIT Varioset DB S+B Premium	14	570 x 1550 x 2100 (22.4 x 61.0 x 82.7)	115	–	400	–	–
VEIT Varioset CR2 S+B Premium	14	800 x 1620 x 2100 (31.5 x 63.8 x 82.7)	115	–	400	–	–
VEIT Varioset Men's / Ladies' Wear Finish ironing table S+B	15	1580 x 840 x 1140 (62.2 x 33.1 x 44.9)	115	–	400	–	–
VEIT Varioset Men's / Ladies' Wear lining table S+B	15	1580 x 840 x 1140 (62.2 x 33.1 x 44.9)	115	–	400	–	–
VEIT Uniset S trouser seam ironing table	16	780 x 1650 x 1775 (30.7 x 65.0 x 69.9)	74	–	230	–	–

Important facts about VEIT Steam Generators

When purchasing a steam generator, it is essential to keep an eye on the required boiler size (litres), the power (kW) and the pressure capacity. These criteria are decisive for the optimal compatibility of the steam generator and the application, e.g. when using Finishers. In addition this data classifies the category of the boiler.

DGR 97/23 (PED 97/23 EC)			
	Steam generator size in bar x litres	Required classification	VEIT products
Category I	< 50	CE (without 4-digit TÜV numbers)	SG 67, SG 66
Category II	50 – 200	CE with 4-digit TÜV-number, e.g. TÜV-Southern Germany CE 0036	2373
Category III	200 – 3000	CE plus with 4-digit TÜV numbers	2381
Category IV	> 3000	CE plus with 4-digit TÜV-numbers	Steam Generators

Setup and installation in Germany:

- > **Category I and II:** no approval by the authorities required
- > **Category III:** Approval of installation required. Maintenance plan has to be submitted. (Except for VEIT 2381, which is delivered as a ready-to-use aggregate. For this machine, no approval is necessary, but the plan has to be submitted.)
- > **Category IV:** Installation must be authorised and approved by the authorities in charge

* height with iron gantry: 2100 mm (82.7 inch)

Steam Generators

Type	Page	Dimensions		Connections			
		L x W x H mm (inch)	Weight kg	Steam max kg/h	Voltage V/kw	Steam pressure bar	Steam connection
Small Steam Generator VEIT SG 67	18, 19	253 x 420 x 622 (10.0 x 16.5 x 24.5)	32	3	230/2,2	3,0	3/8
Small Steam Generator VEIT SG 66	20	305 x 652 x 812 (12.0 x 25.7 x 32.0)	40	3/6/9	230/2,2 bzw. 400/4,4/ 6,6	3,5–4,0	3/8
Small Steam Generator VEIT SG 66 MF	20	230 x 360 x 695 (9.1 x 14.2 x 27.4)	19	3	230/2,2	3,5–4,0	3/8
Steam Generator VEIT 2373	20	790 x 620 x 1210	121	18,4/24,5/ 33,3/41	400/13,5/18/ 24,5/30	5,0	3/8
Steam Generator VEIT 2381	21	1080 x 780 x 970	340	55,68,78	400/40,50,60	6,0–7,0	3/4

Type	Page	Connections				
		Steam inch	Water inch	Condensate inch	Waste Water inch	Exhaust Steam inch
VEIT SG 67 2,2 kW	18, 19	3/8"	optional	–	–	–
VEIT SG 67 4,4 kW	18, 19	2 x 3/8"	optional	–	–	–
VEIT SG 67 6,6 kW	18, 19	2 x 3/8"	optional	–	–	–
VEIT SG 66	20	3/8"	3/8"	–	–	–
VEIT SG 66 MF	20	3/8"	–	–	–	–
VEIT 2373 13,5 kW	20	3/4"	1/2" hose clip	1/2"	1/2"	–
VEIT 2373 18 kW	20	3/4"	1/2" hose clip	1/2"	1/2"	–
VEIT 2373 24,5 kW	20	3/4"	1/2" hose clip	1/2"	1/2"	–
VEIT 2373 30 kW	20	3/4"	1/2" hose clip	1/2"	1/2"	–
VEIT 2381 40 kW	21	3/4"	3/8"	1/2"	3/4"	1 1/4"
VEIT 2381 50 kW	21	3/4"	3/8"	1/2"	3/4"	1 1/4"
VEIT 2381 60 kW	21	3/4"	3/8"	1/2"	3/4"	1 1/4"

* other voltages on request
Subject to alterations

The VEIT Group



Pressing for Excellence – Why you can rely on the VEIT Group

The VEIT Group is based in Landsberg am Lech (Germany) and is the leading manufacturer worldwide for machines and plants in the field of ironing, fusing, pressing and refinishing of garments. Our product portfolio ranges from traditional ironing tables and presses to fusing machines and also includes automated units.

VEIT Group: the story of our success

- 1956 Foundation of VEIT Group with now 14 companies in 12 countries worldwide
- 1989 Purchase of BRISAY, Aschaffenburg, with a portfolio of cutting-edge ironing machines
- 2001 Acquisition of Kannegiesser GTT in Vlotho with their internationally renowned fusing machines and shirt ironing machines
- 2003 Production and further development of Kannegiesser products through VEIT
- as of 2014 Distribution of Kannegiesser products exclusively under the VEIT brand name

Quality

For over 60 years, our customers' requirements and challenges have been our driving force to press for excellence. For decades, world famous brands in the German and international garment industry have placed confidence in the innovative, high quality products and services offered by the VEIT Group.

Efficiency

Our experts consult and partner with you in finding the best possible solution for your project needs, whether you require individual machines or a complete product line.

Service

Prompt delivery and professional installation of our machines and systems go hand in hand with premium training, through which we equip your staff with the skills necessary to achieve the highest possible production. Our service technicians are always available, around the world and around the clock, maximizing continuous production.



VEIT GmbH

Justus-von-Liebig-Str. 15
 86899 Landsberg/Lech
 Deutschland
 Tel. +49 (8191) 479-100
 Fax +49 (8191) 479-149
 E-Mail: info@veit.de
www.veit-group.com

Your local sales agent:

